

RECUPERATOR OPERATING MANUAL

AHR PLUS

IMPORTANT INFORMATION

Please read the Operating Manual carefully before assembling it or any other activity related to work with the appliance! **AWENTA shall not be liable for any damage resulting from incorrect operation, non-intended use or unauthorized repair or modifications of the product.**

The Operating Manual and the installation instructions contained in it are an essential part of the product equipment. The Operating Manual specifies important technical information and instructions for the operating safety. Carefully read the assembly manual and keep it available in a readily accessible place for future reference. A copy of the operating manual can be downloaded from www.awentapro.pl



Safety information

The following safety symbols show important safety information. Follow all safety regulations and the safety symbols shown in the Operating Manual to avoid injury and hazards.



Electric shock hazard



Danger!
– high voltage!



Caution:
rotating components!

Safety precautions:

- This equipment may be used by children of at least 8 years of age and by persons with reduced physical or mental abilities and persons with no experience or knowledge of the equipment if supervised or instructed on its safe use so that the risks associated with it are understandable. This product is not a toy and children should not play with it. Children should not be allowed to clean or maintain the product without supervision of an adult.
- The appliance is intended for permanent installation and connection with the building electrical system. The building electrical system connected to the air exhaust fan must be capable of breaking live voltage contact on all switching poles to fully isolate the air exhaust fan from power during Category III overvoltage conditions, in accordance to applicable electrical engineering regulations.
- The appliance is only intended for installation in a position and an orientation specified in the Operating Manual, given the necessary entry of the power supply cable into the air exhaust fan housing.
- Before servicing the appliance, isolate it completely from the mains voltage with the circuit breaker. Secure the circuit breaker against inadvertent operation.
- The air exhaust fan installation design must prevent reverse flow of flue gas into the room from open flue gas exhaust ducts and appliances operated with open flames.
- Never attempt to modify or alter the air exhaust fan without authorisation.
- Before installing the appliance, check the load capacity of structural components, to which it will be attached, as improper attachment can result in damage to or destruction of the appliance, as well as cause hazard to the persons nearby.



The appliance can be hazardous when operated against its intended use or installed by unqualified personnel.

Application and operating conditions

- The recuperator is intended for pumping air of normal quality or with a low dust content (with a particle size $< 10 \mu\text{m}$) and without aggressive chemicals or high humidity. The air exhaust fan is intended for operation in temperate climate conditions.
- The appliance may be operated only in a permanent indoor installation and with its power supply cable concealed.
- The permissible operating temperature range of the AHRP160 unit is -20°C to $+40^{\circ}\text{C}$.
- The permissible operating temperature range of the AHRTH sensor is $+5^{\circ}\text{C}$ to $+40^{\circ}\text{C}$.

- The appliance is compliant with IP22, electrical protection class II.
- The appliance must be operated according to its intended use and within the performance limits specified on the nameplate.
- **The fan should be connected to the permanent electrical installation with a 2x1.5 mm² or 3x1.5 mm² cable with a maximum external diameter of 14,5 mm.**
- Do not use the recuperator to pump air with the following content:
 - viscous contaminants prone to deposition in the appliance;
 - corrosive contaminants which may degrade the appliance,
 - flammable contaminants, including gas, vapours, mists or particulates which may form explosive mixtures with air.
- The control system must prevent extremely frequent power cycling.
- The appliance must be installed in an external partition/wall, at a sufficient distance from pollution sources (chimneys, flue gas, etc.) to ensure pollution-free drawn/supplied air.
- The ventilation duct should be installed with a slope of approx. 1% towards the outside. **The appliance must not be installed in a vertical position (in the ceiling, roof).**
- The appliance should be installed with the electrical compartment in the bottom.

Transport and storage

- Store the appliance in its original packaging, in a dry, sheltered room.
- The transport and storage ambient temperature limits are: -20°C to +40°C.
- Protect from impact and shock. Transport the appliance in its original packaging.
- For a storage time longer than 1 year, check if the rotor rotates freely before installation.
- The disposal of the appliance must be conducted properly, in accordance with environmental protection and waste management laws.
- Any damage caused by improper transport, storage or commissioning shall be proved and it is not covered by the warranty.

PRODUCT DESCRIPTION AND EQUIPMENT

Product description:

The AHR PLUS recuperator is equipped with a ceramic regenerative heat exchanger. The heat lost in the ventilation process can only be recovered in the recuperation mode. The time of operation in the supply and exhaust direction is selected automatically based on readings from temperature sensors placed within the appliance.

The AHR PLUS appliance is equipped with a bi-directional motor, with three rotational speeds.

Equipment:

The kit consist of:

1. The AHRP160 appliance
2. AHRTH wireless temperature/humidity sensor
3. Remote controller
4. Mounting dowels – 4 pcs.
5. G3 class filter (optional)

Fig. 1

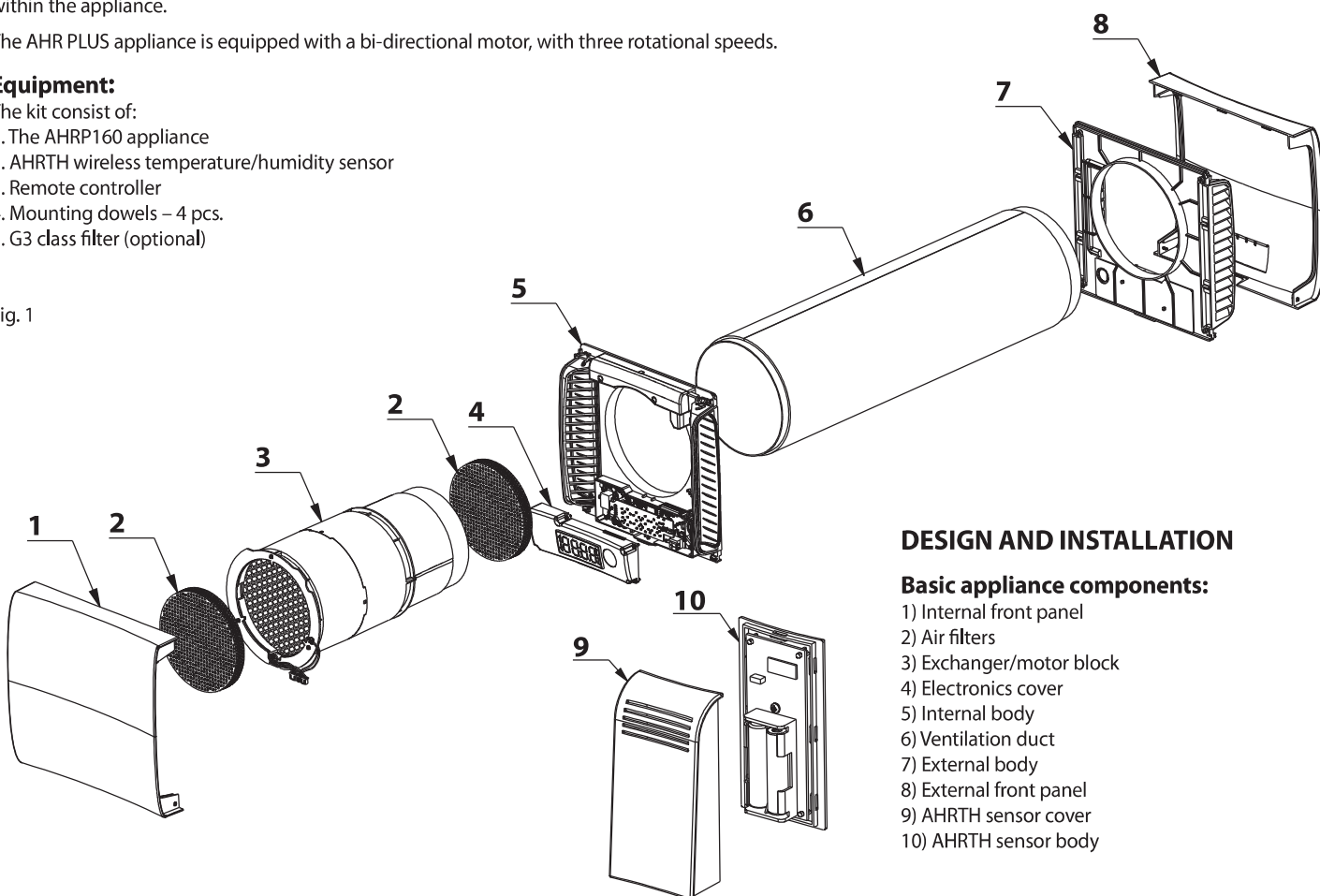

DESIGN AND INSTALLATION

Basic appliance components:

- 1) Internal front panel
- 2) Air filters
- 3) Exchanger/motor block
- 4) Electronics cover
- 5) Internal body
- 6) Ventilation duct
- 7) External body
- 8) External front panel
- 9) AHRTH sensor cover
- 10) AHRTH sensor body



The appliance shall only be installed, connected to electrical mains and commissioned for use by qualified personnel in accordance with applicable laws!

Recuperator installation procedure

- Precisely determine the appliance installation place.
- Prepare the power cable indicated in chapter „Application and operating conditions“.
- Note: Before starting work, make sure that the power cord is not live.**
- Measure and make an opening with a diameter of Ø180 mm for the ventilation duct in the external wall (Fig. 2.1).
- Note: The opening diameter should be greater than the external duct diameter to leave room for sealing.**
- Loosen the locking screws, then remove the internal front panel (Fig. 2.2-2.3).
- Disconnect the motor and temperature sensor connectors, then slide out the exchanger/motor block (Fig. 2.4-2.5).

- Cut the ventilation duct to the appropriate length depending on the wall thickness. Pipe length = wall thickness + 10 mm (Fig. 2.6)
- Cut the insulation mat to the appropriate length. The mat should be 11 mm shorter than the duct from the side of the room and 22 mm shorter from the side of the external body (Fig. 2.7).
- Place the ventilation duct in the external wall and then seal with installation foam (Fig. 2.8):
 - the duct should be flush with the wall from the inside of the building.
 - the duct should be installed with a slight slope to the outside.

Note: Excessive amounts of installation foam can result in the crushing of the ventilation duct.

- Unscrew and then remove the electronics cover (Fig. 2.9-2.10).
- Unscrew and then remove the cable clamp (Fig. 2.11-2.12).
- Measure and make openings for mounting dowels of the internal body (Fig. 2.13-2.14).
- Run the power supply cable in double insulation through the grommet. Run a cable with a sufficient length to enable connection to power terminals after installation. The minimum length of the cable in the external insulation is 10 mm (inside the chamber) (Fig. 2.15).
- Place the internal body on the ventilation duct and then attach it using the mounting dowels included in the package (Fig. 2.15).
- Connect the electric wire to the power supply terminals according to the diagram (Fig. 4), and then secure it with a clamp (Fig. 2.16-2.17).

NOTE: Unused cable conductors must be insulated.

- Set the appropriate slider configuration in the appliance controller (Fig. 2.18).
- Note: The slider configuration is described in section CONTROL AND FUNCTIONALITY.**

- Place and then screw the electronics cover (Fig. 2.19).
- Slide the exchanger/motor block into the ventilation duct and then connect the motor and temperature sensor connectors (Fig. 2.20-2.21).
- Place and then screw the internal front panel (Fig. 2.22-2.23).
- Loosen the locking screws, then remove the external front panel (Fig. 2.24-2.25).
- Measure and make openings for mounting dowels of the external body (Fig. 2.26-2.27).
- Place the external body on the ventilation duct and then attach it using mounting dowels (Fig. 2.28).

Note: Select the right type of mounting dowels for the type of substrate.

- Place and then screw the external front panel (Fig. 2.29-2.30).

AHRTH sensor installation procedure

- Determine the sensor installation place (the sensor should be located minimum 1 m from the floor, away from heat sources, such as radiators or TV). The sensor can be placed by the wall or attached to it.
- Remove the snap-on sensor cover (Fig. 3.1).
- Insert 2 x AAA (RL03) 1.5 V batteries (Fig. 3.2).
- **For wall mounting:** Make an opening and place a dowel/nail in the wall, then hang the sensor using the opening on the back of the housing (Fig. 3.3-3.5).
- Pair the sensor with the recuperator as described in the section "Functionality" (Fig. 3.6).
- Place the sensor cover (Fig. 3.7).

Installing a G3 class filter

- Unscrew the locking screws and then remove the external front panel;
- Remove the unit's non-rated filter located on the inside;
- Insert a G3 class filter (its black side must be facing the room's interior);
- Attach and screw on the external front panel;

NOTE: Using a G3 class filter decreases the unit's performance by approximately 13%.

CONTROL AND FUNCTIONALITY

Turning the appliance on and off:

To turn on/off the appliance, push the  button in the bottom part of the front panel of the appliance or on the remote controller. Turning the appliance on/off is indicated with the following messages:



Description of remote control buttons:

Torque speed change:

The speed is changed by pushing buttons , , .

Operating mode change:

The operating mode is changed by pushing buttons:

 - RECUPERATION mode. The flow direction is changed automatically based on the temperature measurement.

 - AIR SUPPLY mode. Continuous operation in the air supply direction.

 - AIR EXHAUST mode. Continuous operation in the air exhaust direction.

Control functions:

The control function is activated by pushing buttons:

 - HIGRO mode. The rotation speed depends on the set and currently measured humidity.

 - TIMER mode. It enables turning off the appliance automatically after 5-180min.

 - NIGHT mode (silent). Pushing the button activates the night mode, which will be turned on at the selected clock time during the day.



Synchronous operation:

 - SYNCHRO mode. For a "Master" appliance, it starts synchronous operation of all paired appliances. For a "Slave" appliance, it restores synchronous operation.

Additional buttons:

 - SET button. It enables setting the clock timer, night mode operation time and resetting filter contamination counter.

 - DISPLAY button. It changes the currently displayed information. Pushing the button toggles the following displays:

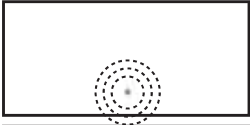

• Screen 1 - Display dimmed (dot flashing in the active ventilation mode and dot lit continuously in the off mode);



• Screen 2 - Flow direction + speed + room humidity;

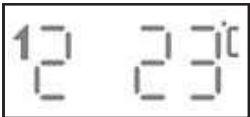

• Screen 3 - Flow direction + speed + room temperature;





• Screen 4 - Clock;





• Automatic change - Sequential display of screens 2, 3 and 4 (changes every 5 seconds).

Functionality:

Clock setting:

- To enter the clock setting procedure, push the  button and then (without releasing the  button) push the  button.
- A flashing clock showing the currently set time will appear on the screen.





- Set the current time using the  (hours) and  (minutes) buttons.
- To confirm the clock settings, push the  button and then (without releasing the  button) push the  button.

Air filter operation time counter:

- After total 90 days of appliance operation, the following message will appear on the screen to inform that the filters require cleaning.



- This information will be displayed for a few seconds immediately after the appliance is turned on.
- After completing filter maintenance, reset the counter.
- To reset the counter, push the  button and then (without releasing the  button) push the  button.

HIGRO mode (for controller versions V1 and V2):

- To activate this function, push the  button on the remote controller. To change the set humidity threshold, toggle the button:

10%* → 20% → 30% → 40% → 50% → 60% → 70% → 80% → 90% → OFF (return to the home screen after 5 s)

* if the HIGRO mode is currently enabled, the first push of the button will display the currently setpoint.

- During operation in the HIGRO mode, the appliance compares the measured room humidity with the setpoint. The current speed of the appliance is based on the following relationship:
 - the measured value is smaller than the setpoint - fan off
 - the measured value is 0-10% greater than the setpoint - speed 1
 - the measured value is 10-20% greater than the setpoint - speed 2
 - the measured value is 20-30% greater than the setpoint - speed 3

Note: Changing the speed or direction of flow while in HIGRO mode will switch to manual operation.

- The activation of the HIGRO mode is indicated by the flashing  symbol on the screen of the appliance. Example:

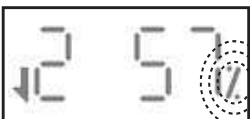

HIGRO mode (for controller version V3):

- To activate this function, push the  button on the remote controller. To change the set humidity threshold, toggle the button:
10%* → 20% → 30% → 40% → 50% → 60% → 70% → 80% → 90% → OFF (return to the home screen after 5 s)
* if the HIGRO mode is currently enabled, the first push of the button will display the currently setpoint.
- During operation in the HIGRO mode, the appliance compares the measured room humidity with the setpoint. The current speed and direction of the device are derived from the relationship below:
 - the measured value is smaller than the setpoint - fan off
 - the measured value is 0-10% greater than the setpoint - speed 1 (without affecting the current direction of work)
 - the measured value is greater than the setpoint by 10-20% - speed 2 and automatic switching to EXHAUST mode.
 - the measured value is higher than the setpoint by 20-30% - speed 3 and automatic switching to EXHAUST mode.

Note: Changing speed while working in HIGRO mode will result in switching to manual operation.

Changing the operation mode (to e.g. SUPPLY) while operating in HIGRO mode will deactivate the automatic switching to EXHAUST mode until the HIGRO function is activated again. However, it does not result in a complete exit from HIGRO mode.

- The activation of the HIGRO mode is indicated by the flashing  symbol on the screen of the appliance. Example:



TIMER mode:

- To activate this function, push the  button on the remote controller. To change the set turn-off delay, toggle the button:
5min* → 10min → 15min → 30min → 45min → 60min → 120min → 180min → OFF OFF (return to the home screen after 5 s)
* if the TIMER mode is currently enabled, the first push of the button will display the current time until turning off.
- If the HIGRO mode has been enabled, when the TIMER is enabled, the HIGRO mode is disabled and the appliance starts running at speed 1.
- Changing the speed and direction in TIMER mode does not affect the operation of the clock;
- After the set time has elapsed, the appliance will be turned off and the last used speed will be remembered.
- Activation of the TIMER mode is indicated by sequential lighting of the LEDs (top to bottom) in the central part of the display.

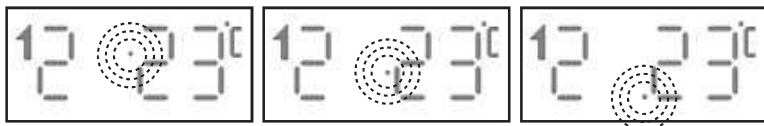

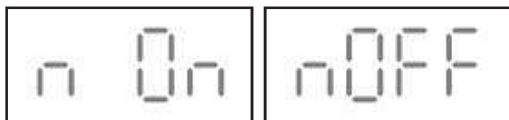

NIGHT (silent) mode:

- When activated, the night mode is started automatically at the selected clock time. Operation in the night mode ensures continuous ventilation of the room with reduced noise emissions.
- To activate this function, push the  button on the remote controller. The activation/deactivation of the night mode is indicated with the following messages:





- During operation in the night mode, the appliance automatically switches to RECUPERATION mode. The speed is determined by room humidity, according to the following relationship:
 - the measured humidity is lower than 70% - speed 1;
 - the measured humidity is higher than 70% - speed 2.



Night mode start and end time setting:



- To set the night mode operation start and end hour, push the  button and then (without releasing the  button) push the  button.
- The flashing "n On" message will be displayed on the screen.



- Next, use the  (hours) and  (minutes) buttons to set the desired night mode operation start hour (the first push of the button will display the current set hour).
- After setting the desired night mode operation start hour, push the  button again..
- The flashing "n OFF" message will be displayed on the screen.



- Next, use the  (hours) and  (minutes) buttons to set the desired night mode operation end hour (the first push of the button will display the current set hour).

- After setting the set hour, push the  button and then (without releasing the  button) push the  button.

Note: By default, the set night mode operation time is 11 p.m. to 5 a.m.

Slider configuration (placed on the device controller):

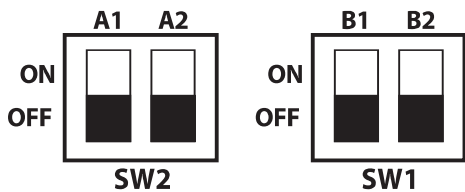

| Function | Value | A1 | A2 | B1 | B2 |
|-------------------------------------|---------------|-----|-----|-----|-----|
| Appliance type | MASTER | ON | | | |
| | SLAVE | OFF | | | |
| SLAVE appliance operating direction | same | | ON | | |
| | opposite | | OFF | | |
| Synchronous operation | permitted | | | ON | |
| | non permitted | | | OFF | |
| Communication with BT sensor | permitted | | | | ON |
| | non permitted | | | | OFF |

Pairing the AHRTH temperature/humidity sensor:

- Check if the B2 slider is set to ON (permitted).
- Turn off the appliance, then press the  button on the unit for 2 seconds..
- The following message will be displayed on the screen:

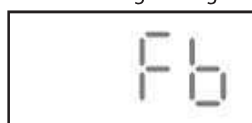

- Then push the  button on the unit again for 2 seconds. The "Fb" symbol with flashing bars will be displayed on the screen.

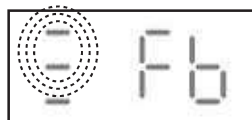

- Push the micro-button on the electronic system of the AHRTH sensor (**Fig.2.18**).
- Upon proper pairing, all three bars will be lit simultaneously on the display of the appliance.

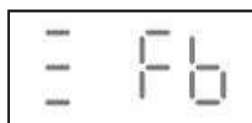



- To complete the pairing procedure, push the  button on the appliance.
- Note:** The pairing of the AHRTH sensor is necessary for proper operation of the appliance.

Pairing the appliances for synchronous operation:

- Check if the B1 slider of all appliances is set to ON (permitted).
- Set the status of the A1 dipswitch as appropriate:
 - in the MASTER appliance, in the ON (MASTER) position;
 - in other appliances, in the OFF (SLAVE) position.
- Note:** Only one MASTER appliance can be present in the network!
- Set the status of the A2 slider of all SLAVE appliances as appropriate:
 - operation in the same direction as the MASTER - ON (same);
 - operation in the opposite direction to the MASTER - OFF (opposite).

Note: It is recommended that the number of appliances operating in the same and opposite direction is the same. If there is only one SLAVE appliance, the slider should be set to OFF (opposite).

Perform operations on the MASTER and SLAVE appliances

- Turn off all devices and then push the  button on the unit for 2 seconds.
- When the "Fb" message is displayed on screens, then push (briefly) the  button on the unit. The "Fn" message will appear.

- Then push the  button again for 2 seconds. The "Fn" symbol with flashing bars will be displayed on the screen.

- After proper pairing, three bars will be lit simultaneously on the display of the SLAVE appliance (the bars will continue flashing on the MASTER appliance).



- After 30 seconds, the following symbol will appear on the display of the MASTER appliance:





Note: If pairing is not completed and 30 seconds elapse, then the following message will be also displayed on the SLAVE appliance. Then, the pairing procedure must be repeated.

- To complete the pairing procedure, push the  button on the MASTER and SLAVE appliances.

Synchronous operation:

- It is possible to synchronise the operation of two or more appliances. To ensure proper flow balance, it is recommended that the number of appliances in the room is even.
- There can be only one MASTER appliance in the network of synchronised appliances. During synchronous operation, all SLAVE appliances operate at the same speed and in the same or opposite direction (depending on the slider setting).
- To enable the synchronous operation function, then (after prior completion of the pairing procedure) push the  button on the remote controller of the MASTER appliance.
- Synchronous operation is indicated with the “—” symbol displayed on the screens of both the MASTER and SLAVE appliances. Example screen below:



- To enable synchronous operation of the SLAVE appliance, its B1 slider must be set to ON.
- If the MASTER appliance operates with the recuperation option, then the SLAVE appliance will display its actual operating direction.
- Synchronisation is possible in all operating modes of the MASTER appliance (recuperation, air supply, air exhaust, timer, higo, night).
- If any function on the remote controller of the SLAVE appliance (e.g. speed or operating mode) is used during synchronous operation) synchronisation with that appliance will be interrupted. To return to synchronous operation, push the  button on the remote controller of the SLAVE appliance or complete synchronisation, namely turn off and on the synchronisation in the MASTER appliance.
- If SLAVE appliances are turned off, when the synchronisation is activated, they will be turned on automatically.
- Turning on/off the appliances with the  button will not interrupt synchronisation,
 - for the MASTER appliance, it turns off/on all paired appliances.
 - for the SLAVE appliance, it turns off/on only the SLAVE appliance.

Note: Synchronisation will be interrupted if the MASTER appliance is turned off, when the SLAVE appliance is turned on.

AWENTA AHR mobile app

The recuperator features a Wi-Fi module for remote control via the AWENTA AHR mobile app. The Android version of the app is available in the Google Play store.



<https://play.google.com/store/apps/details?id=com.awenta.pro>

First start-up

Start the appliance only with all safety precautions in place and all hazards eliminated. Start the appliance. Check that it runs steadily and the air is handled efficiently.

Check the operation of the fan (noise, vibration, power consumption, the possibility to control the rotation speed).

The appliance may be used only with front panels (internal and external) that prevent touching the moving parts. The user is liable for compliance with current safety standards and may be held liable for accidental injury or death caused by failure to provide the required safety.

Electrical connections

- Electrical connections and commissioning of the air exhaust fan shall only be completed by qualified professional electricians.
- Always follow the applicable standards, safety regulations and technical requirements specified by the power company!
- The power supply line for the air exhaust fan requires a multi-pole circuit breaker / isolation switch with a minimum contact break gap of 3 mm (ref. PN-EN 60335-1)!
- The mains system, voltage and frequency must match the nameplate ratings.
- **After a power failure, the unit restores the last saved operating parameters (speed setting, flow direction). The settings are saved every 25 seconds from the last parameter change.**

Dimensions

The dimensions are shown in Figure 5 and 6.

MAINTENANCE AND CLEANING



Electrocution hazard by damaged wiring insulation!
Lock out and tag out the appliance before any maintenance works!

Servicing and maintenance

- Use protective footwear and gloves during maintenance!
- During all maintenance and servicing works the electrical and OHS regulations (PN-IEC 60364-3) must be observed.
- Before servicing the fan, isolate it from the mains voltage with the circuit breaker. Secure the circuit breaker against inadvertent operation!
- The fan ductwork must be clear of foreign bodies: hazard of injury by objects blown out at a high speed!
- Do not attempt any maintenance when the fan is running or at live voltage!
- If excessive vibrations are felt or heard, have the technical inspection carried out by a qualified electrician.
- The maintenance intervals depend on the actual contamination of the rotor and filter, they must not be longer than 6 months!
- Check the rotor for cracks.
- The manufacturer shall not be liable for any damage resulting from unprofessional repairs.
- The appliance is equipped with motors that have been lubricated for life, the motor is maintenance-free.

Cleaning

- Clean the front panels (external and internal) and visible parts of the housing with a damp cloth.
- Do not use aggressive paint solvents!
- Do not clean with a high pressure cleaner or strong jets of water!
- Clean carefully to prevent water from entering the motor or the terminal box.
- The grid at the inlet/outlet of the fan must be kept clean at all times.
- Clean the filters and the exchanger when the message appears on display of the appliance or every 6 months (the message is displayed for a few seconds after the appliance is turned on).
- **Periodical air filters and exchanger cleaning procedure:**
 - Loosen the locking screws, then remove the internal front panel.
 - Disconnect the motor and temperature sensor connectors, then slide out the exchanger/motor block.
 - Remove the filters from the appliance and then rinse under running water.
 - Clean the accessible components of the exchanger/motor block with a vacuum cleaner or compressed air.
 - After drying, insert the air filters.
 - Slide the exchanger/motor block into the ventilation duct and then connect the motor and temperature sensor connectors.
 - Place and then screw the external front panel.
 - Reset the air filters operation time counter.

WARRANTY TERMS & CONDITIONS

1. The warranty period for proper performance of the appliance is 2 years from the date of the first purchase.
2. The warranty rights and obligations will be void and null without demonstrating a proof of purchase (a receipt or an invoice).
3. The warranty covers all defects and damage attributable to the manufacturer.
4. Have your product delivered for warranty servicing to the manufacturer or the original seller.
5. The manufacturer undertakes to repair the product or replace it with a new counterpart within 14 days from filing your warranty complaint.
6. The warranty does not cover any of the following: damage to the product attributable to improper or unqualified installation, operation against the intended use, improper transport, storage and/or maintenance, any faults attributable to unauthorized repairs, or any accidental damage.
7. The warranty does not cover the installation or the maintenance of the product.
8. For all matters not provided for by this warranty sheet, the Polish Civil Code (Articles 577- 582) shall apply.

Do not dispose of waste electrical equipment with household waste.



The crossed-out wheeled bin symbol on this product that it is waste electrical and electronic equipment (WEEE) at the end of its operating life and shall not be disposed with household waste. The crossed-out wheeled bin symbol specifies that the product is subject to obligatory waste segregation schedules for proper disposal. The appliance is made from recyclable materials and components. The product user shall be required to return the product which has become WEEE to a WEEE collection unit. The operators of WEEE collection units, including local WEEE locations, product resellers and other WEEE collection locations managed by local authorities form a proper waste disposal system. Proper WEEE disposal helps avoid harmful effects to humans and the environment from the risk caused by hazardous components this product may contain. Your household can make an important contribution to the recovery and recycling of WEEE. This contribution fosters a behaviour which helps conserve the natural environment, which is a common asset for the mankind. Households are among the leading consumers of small appliances and equipment. A rational management of operation and disposal of small appliances and equipment will contribute to efficient recycling.

ADDITIONAL INFORMATION

- The frequency range of AHRP160 and AHRTH: 2,400 - 2,4835 GHz
- AHRP160 maximum radio frequency power: +20 dBm / AHRTH +4 dBm
- AWENTA Sp. J. hereby declares that the AHRP160/AHRTH radio device complies with Directive 2014/53/EU. Find the full text of the EU Declaration at www.awentapro.pl